

YHM2029

400mA Ultra-Low Noise/High PSRR LDO

Features

- Input voltage range: 1.6V ~ 5.5V
- Fixed VOUT:
0.9V/1.2V/1.5V/1.8V/2.0V/2.2V/2.5V/2.7V/2.8V/2.85V
/3V/3.1V/3.2V/3.3V/ 3.5V/4.5V in different version.
- Output accuracy: 2% for all version and temperature range.
- High PSRR: 93 dB @ 1Khz.
- Low noise: 8 μ VRMS @ 10Hz~100Khz.
- Low Quiescent current: 15 μ A
- Over Current protection.
- Output Discharge.
- Thermal Shutdown
- Robust ESD immunity capability
 - HBM > \pm 2KV
 - CDM > \pm 1KV
- Package:
 - Tiny 4-bumps WLCSP 0.67mm x 0.67mm
 - SOT23-5 Pin
 - 4-PIN DFN 1mm x 1mm

Applications

- Camera Power
- Wireless device Power
- Smartphone, Wearable device.
- Noise sensitive device Power.

Typical Application

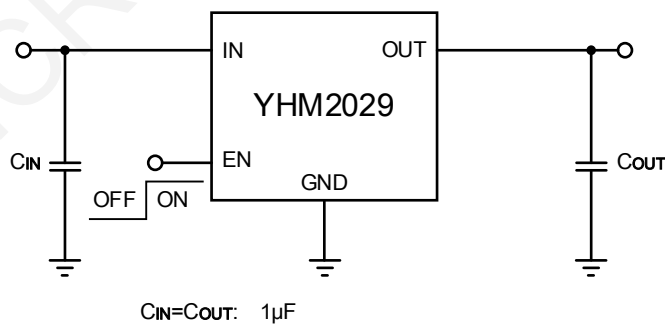

Figure 1. Application Diagram

General Description

YHM2029 is a LDO with ultra-low noise, high PSRR with low quiescent current. It has 400mA output current capability. The device is designed to work with 1 μ F input and output ceramic capacitor. It is very suitable for noise-sensitive, low power consumption requirement and space limited applications.

YHM2029 has OCP function thermal shutdown mode to protect itself during system abnormal situation.

YHM2029 is available in tiny 4-bumps WLCSP 0.67mm x 0.67mm or SOT23-5 package, and operates over an ambient temperature range of -40°C to +85°C.

YHM2029

400mA Ultra-Low Noise/High PSRR LDO

Internal Block Diagram

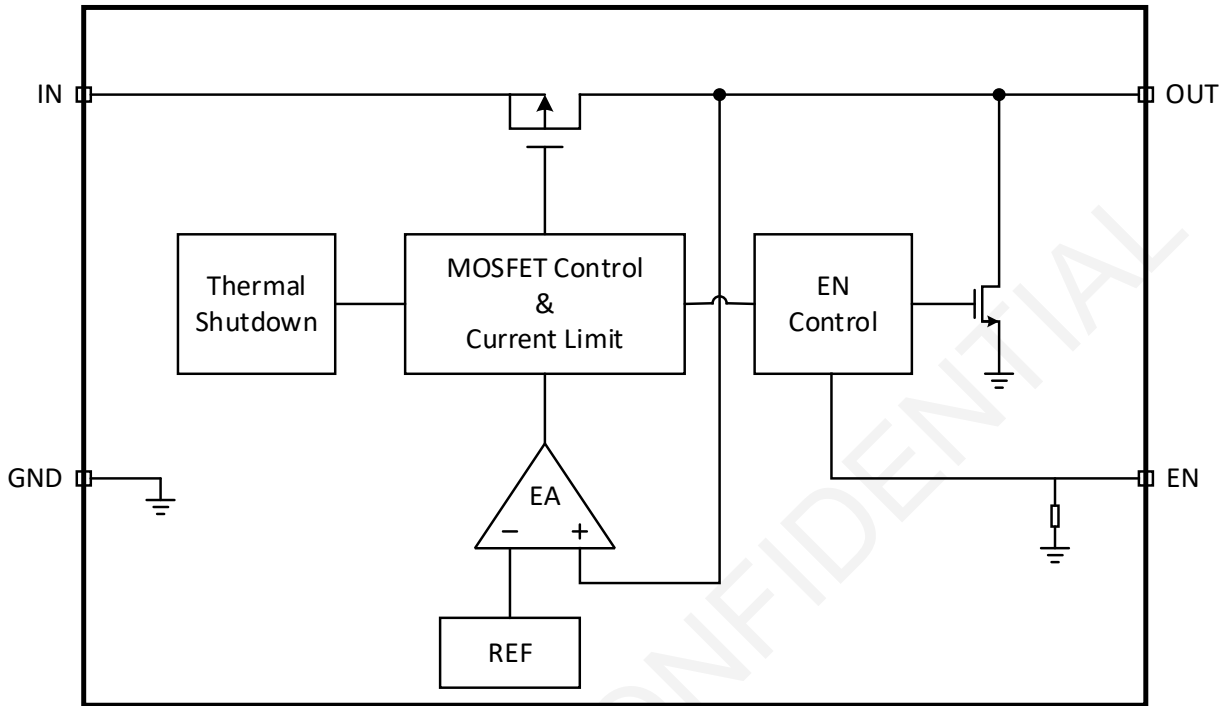

Figure 2. YHM2029 Functional Block Diagram

YHM2029

400mA Ultra-Low Noise/High PSRR LDO

Pin Configurations

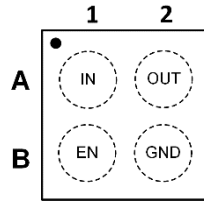

Figure 3. YHM2029 WLP-4 Pin Assignment (Top Through View)

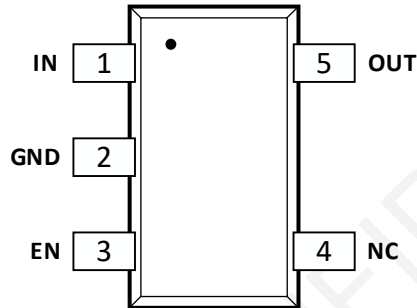

Figure 4. YHM2029 SOT23-5 Pin Assignment (Top View)

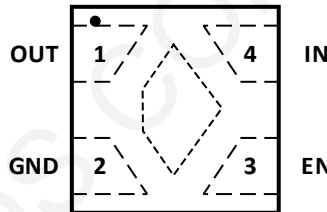

Figure 5. YHM2029 DFN-4 Pin Assignment (Top View)

YHM2029 Pin Descriptions

WLP	SOT23	DFN	Name	Description
A1	1	4	IN	Power Input.
A2	5	1	OUT	Power Output.
B1	3	3	EN	Enable control. Device is active when EN=1.
B2	2	2	GND	Ground Connection.
	4		NC	Not Connected

1 Absolute Maximum Ratings

Stresses exceeding the absolute maximum ratings may damage the device. The device may not function or be operable above the recommended operating conditions and stressing the parts to these levels is not recommended. In addition, extended exposure to stresses above the recommended operating conditions may affect device reliability. The absolute maximum ratings are stress ratings only.

Symbol	Parameter		Min.	Max.	Unit
V _{IN}	IN to GND		-0.3	6	V
V _{OUT}	OUT to GND		-0.3	6	V
V _{EN}	EN to GND		-0.3	6	V
I _{IN}	Input Current (Continuous)			1	A
I _{OUT}	Output Current			1	A
T _{STG}	Storage Temperature Range		-65	+150	°C
T _J	Maximum Junction Temperature			+150	°C
ESD	Human Body Model, ANSI/ESDA/JEDEC JS-001-2012	All Pins	2		KV
	Charged Device Model, JESD22-C101	All Pins	1		

2 Recommended Operating Conditions

The Recommended Operating Conditions table defines the conditions for actual device operation. Recommended operating conditions are specified to ensure optimal performance.

Parameters	Min.	Max.	Unit
Input Voltage: V_{IN}	1.7	5.5	V
Operating Junction Temperature Range	-40	125	°C

3 Electrical Characteristics

Condition: $V_{IN} = V_{SET} + 1V$, $I_{OUT} = 1mA$ or $I_{LOUT} = 1mA$, $T_A = -40^{\circ}C \sim 85^{\circ}C$, unless otherwise noted. Typical value at $T_A = +25^{\circ}C$ and $V_{SET} = 3.3V$, $C_{IN} = C_{OUT} = 1\mu F$

Parameter	Symbol	Test Conditions	Min.	Typ.	Max.	Unit
Input Voltage Range ^(Note 1)	V_{IN}		1.6		5.5	V
EN Logic Voltage ^(Note 2)	V_{ENH}		1.1		5	V
	V_{ENL}				0.3	
EN Pull Down Resistor	R_{ENPD}	$V_{EN} = 5V$		10		MΩ
Output Discharge Resistor	R_{DIS}			150		Ω
Thermal Shutdown Threshold	T_{SD}			150		°C
Thermal Hysteresis	T_{HYS}			20		°C
Output Current	I_{OUT}		400			mA
UVLO Threshold	V_{UVLO}	V_{IN} rising		1.5		V
UVLO Hysteresis	V_{UVLO_HYS}			100		mV
Input Quiescent Current	I_Q	$I_{OUT} = 0$,		15	20	μA
Shut Down Current	I_{SHUT}	$EN = 0$, $T_A = 25^{\circ}C$		0.21	1	μA
Output Voltage Accuracy	A_{OUT}	$I_{OUT} = 0 \sim 400mA$, All V_{SET}	-2		2	%
Dropout Voltage ^(NOTE3)	V_{DO}	$V_{SET} = 1.8V$, $I_{OUT} = 400mA$			300	mV
Line Regulation	LineRe	$V_{IN} = V_{SET} + 1V \sim 5V$, $\Delta V_{IN} = 1V$, $I_{OUT} = 200mA$.		0.02		%/V
Load Regulation	LoadRe	$I_{OUT} = 1mA$ to $400mA$		0.001		%/mA
Output Current Limit	I_{LIM}	$V_{OUT} = 0.9 * V_{SET}$	550	625		mA
Short circuit current ^(NOTE3)	I_{SC}	$V_{OUT} = 0$		70		mA
Power Supply Rejection Ration	PSRR	$I_{OUT} = 20mA$, $V_{SET} = 3.3V$	$f = 1KHz$		93	dB
			$f = 10KHz$		84	
			$f = 100KHz$		65	
			$f = 2MHz$		51	
Output Voltage Noise	V_{NOISE}	$BW = 10Hz$ to $100KHz$, $I_{OUT} = 20mA$		8		μV _{RMS}

Note 1: Output current capability is 270mA when $1.6V \leq V_{IN} < 1.7V$, is 360mA when $1.7V \leq V_{IN} < 1.75V$. And the device has full function when $V_{IN} \geq 1.75V$

Note 2: If the voltage that applied on EN pin higher than 5V, need add one 2Mohm in series.

Note 3: Guarantee by design. Not test on ATE.

4 Typical Operating Characteristics

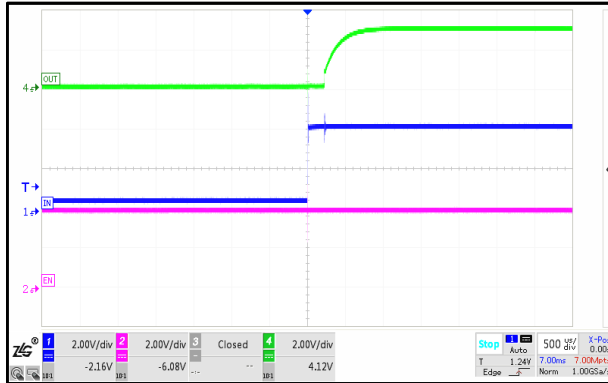
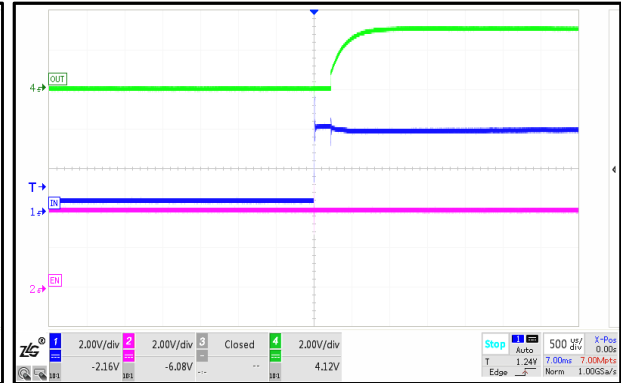
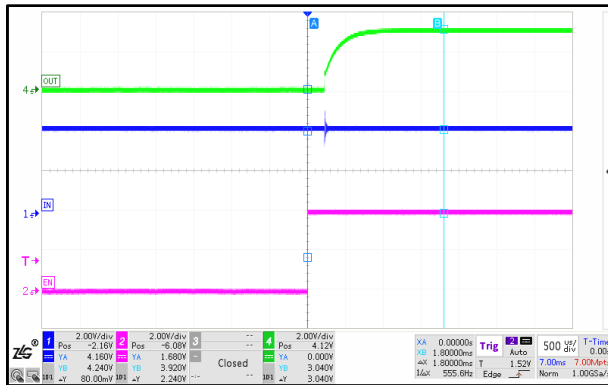
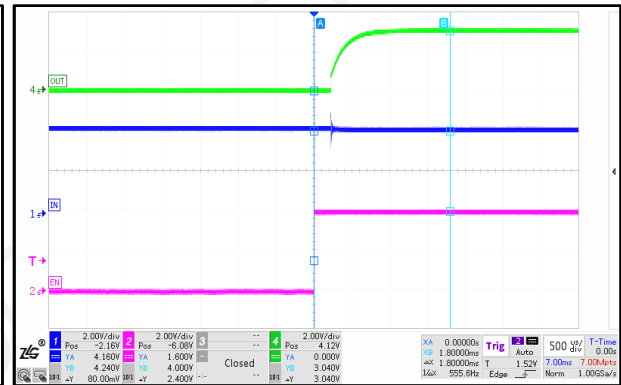
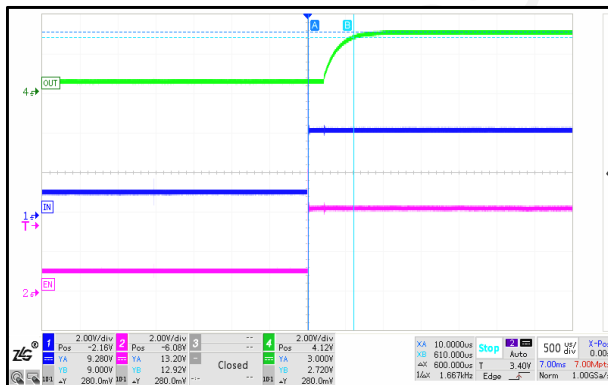
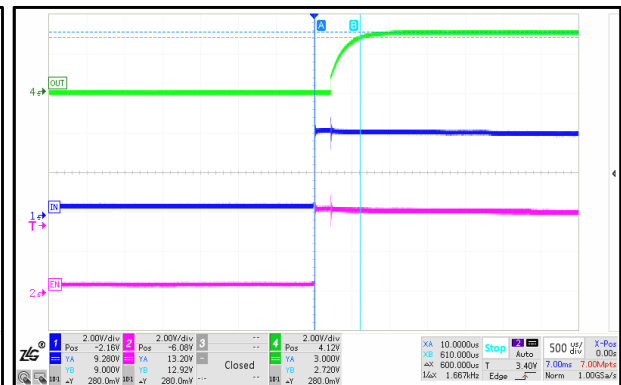
Figure 6. Start-Up with EN before IN ($I_{OUT}=0mA$)

Figure 7. Start-Up with EN before IN ($I_{OUT}=400mA$)

Figure 8. Start-Up with IN before EN ($I_{OUT}=0mA$)

Figure 9. Start-Up with IN before EN ($I_{OUT}=400mA$)

Figure 10. Start-Up with EN tied to IN ($I_{OUT}=0mA$)

Figure 11. Start-Up with EN tied to IN ($I_{OUT}=400mA$)

YHM2029

400mA Ultra-Low Noise/High PSRR LDO

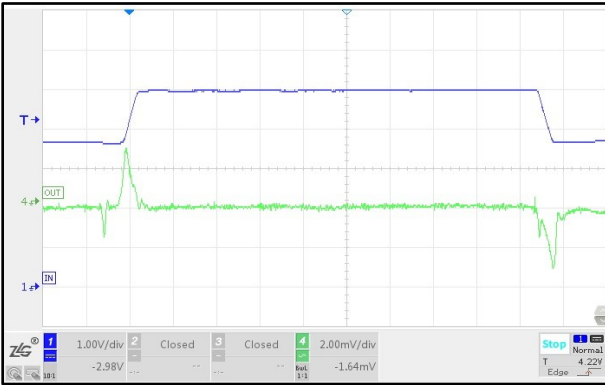

Figure 12. Line Transient ($I_{OUT}=200mA$)

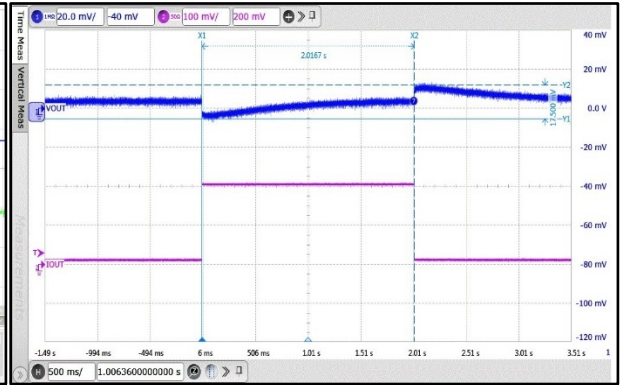

Figure 13. Load Transient($1\mu s$ rising/falling time)

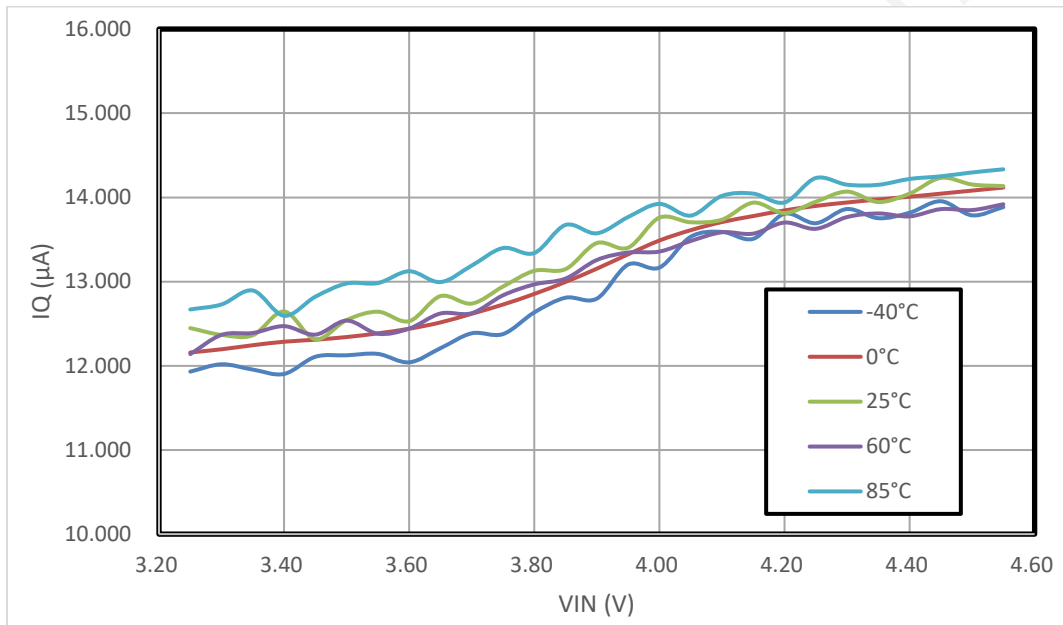

Figure 14. IQ vs VIN ($V_{SET} = 3.3V$)

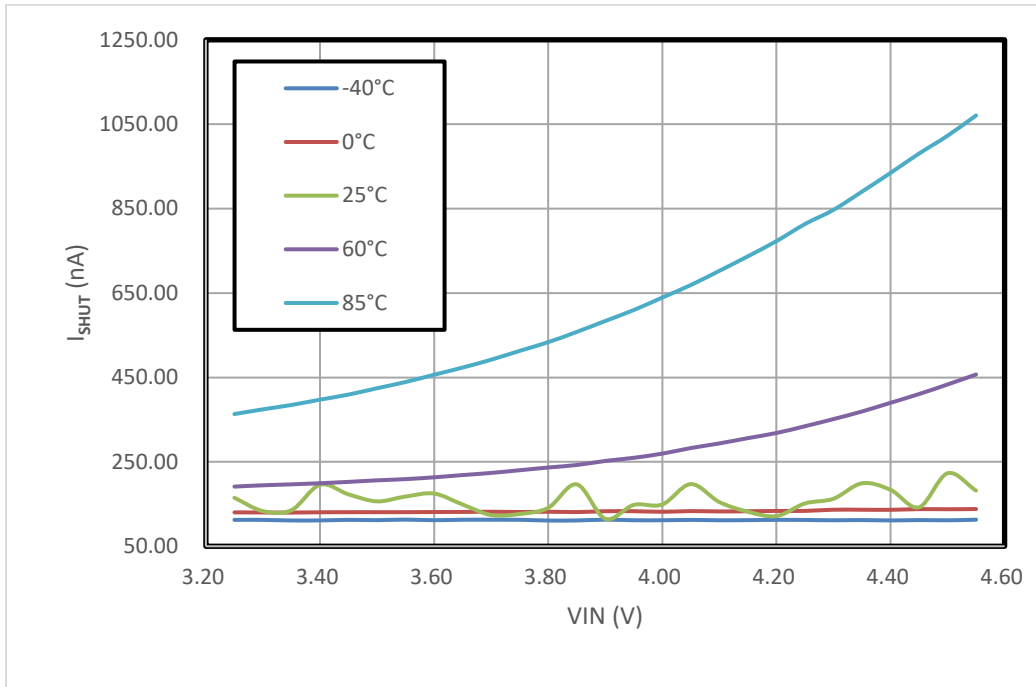

Figure 15. I_{SHUT} vs V_{IN} (V_{SET} = 3.3V)

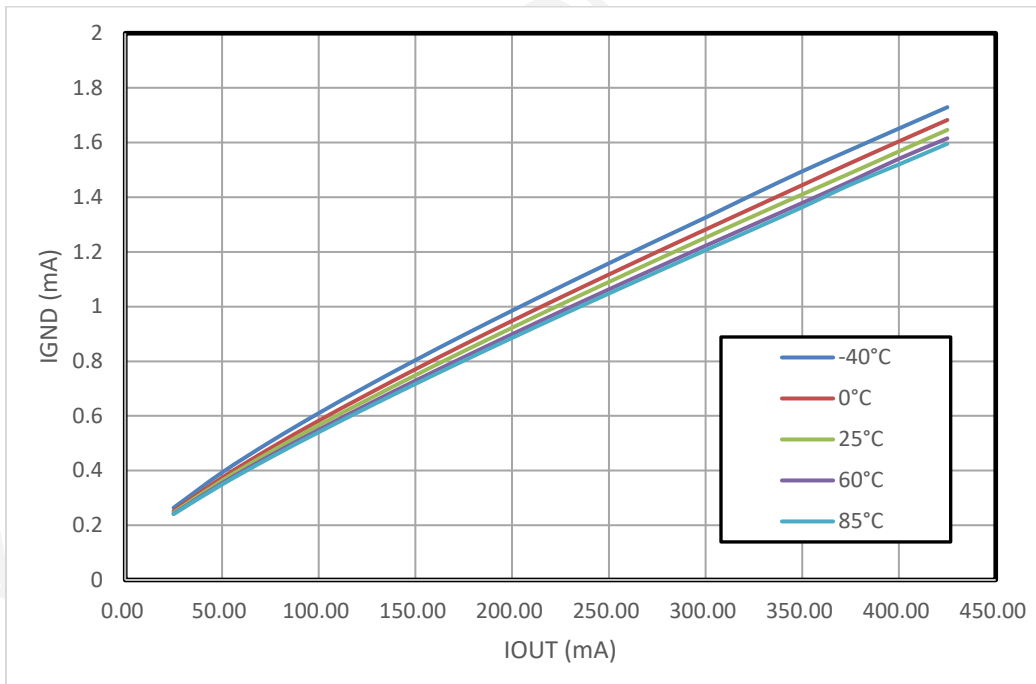

Figure 16. I_{GN}D vs I_OU

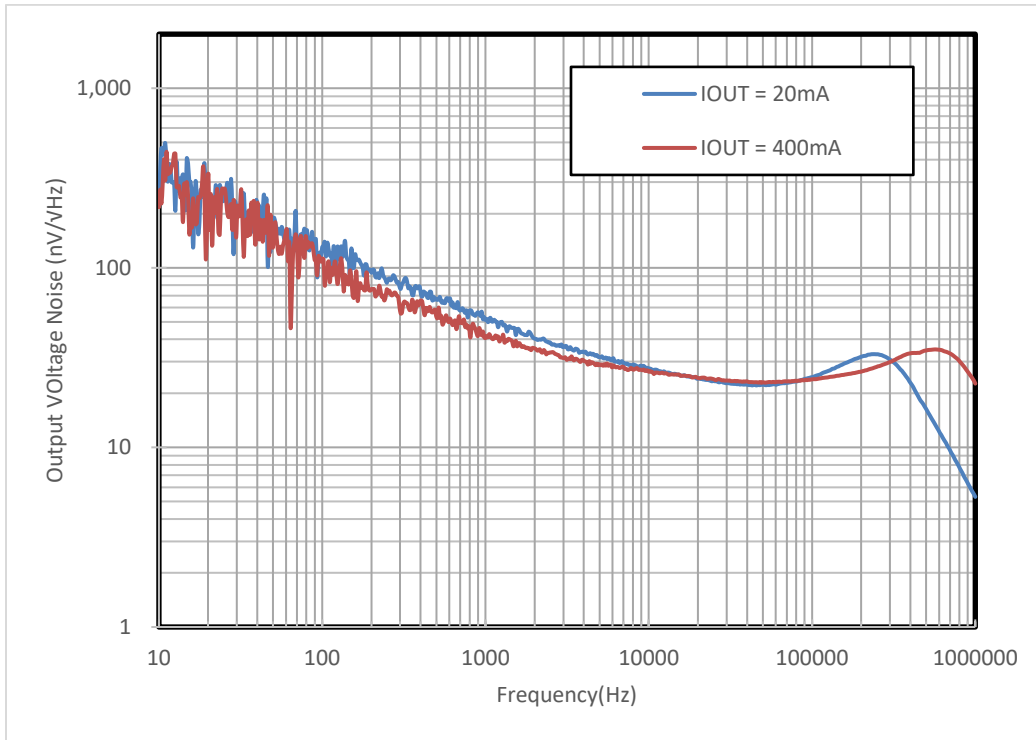

Figure 17. Noise vs Frequency and IOU (COU = 1µF)

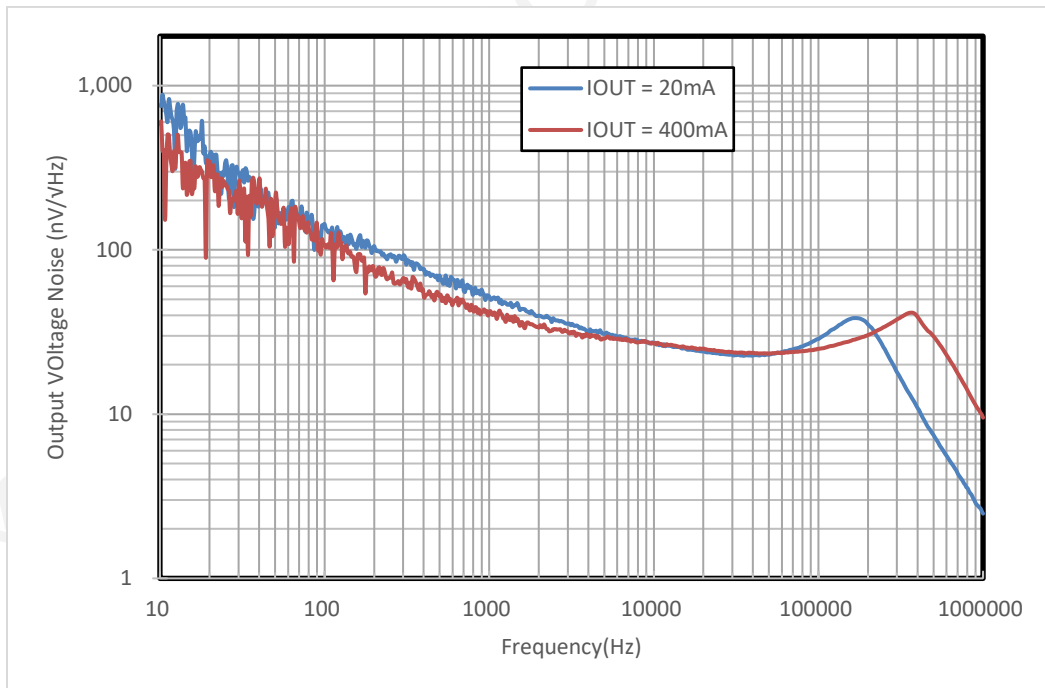

Figure 18. Noise vs Frequency and IOU (COU = 2.2µF)

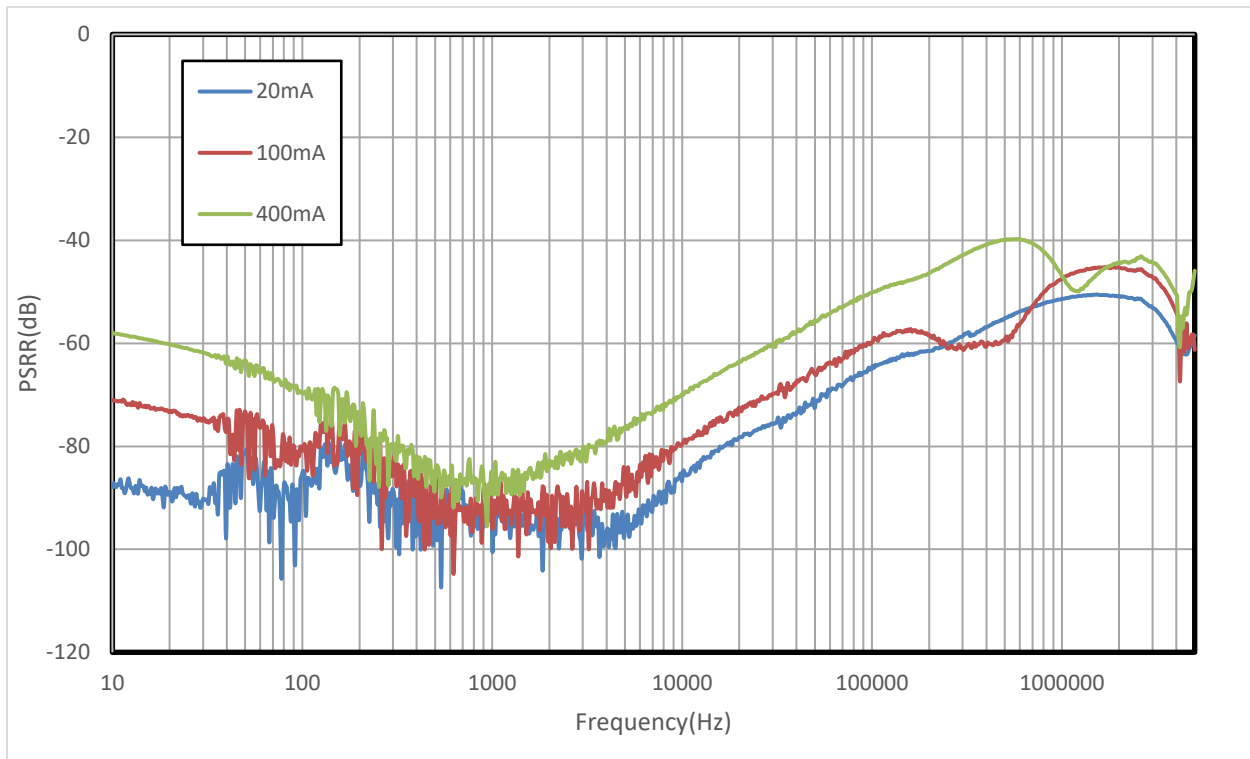

Figure 19. PSRR vs Frequency

5 Detailed Description

5.1 General Introduction

YHM2029 is a low noise, high PSRR LDO which can provide 400mA output current. With very low quiescent current, YHM2029 is suitable for high performance analog circuits and battery powered portable devices.

5.2 UVLO (Under-Voltage Lockout)

The device has a built-in under-voltage lockout (UVLO) circuit in LDO mode. When V_{IN} is rising, the output remains disconnected from the input until V_{IN} voltage is above 1.5V (TYP). This circuit has a 100mV hysteresis to provide noise immunity to transient conditions.

5.3 OCP (Over Current Protection)

The device enters foldback mode when the output load hit the over current threshold or in shorting event. The current is clamped. The output voltage drops. When the voltage drops below foldback voltage threshold, foldback current limit is activated and scales back to short circuit current.

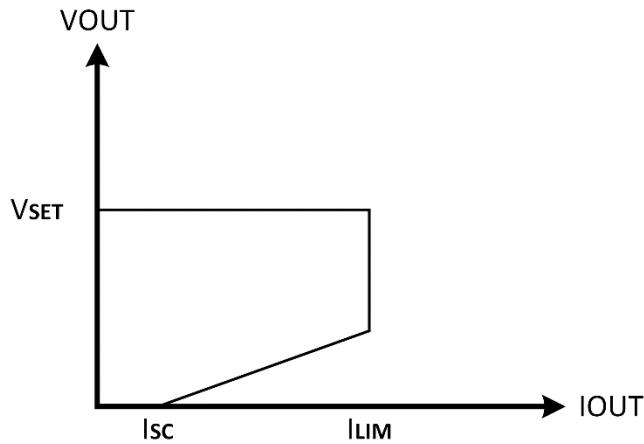

Figure 20. OCP behavior

The OCP threshold is 625mA (typical).

5.4 Thermal Shutdown

YHM2029 has thermal shutdown function. When the junction temperature exceeds T_{SD} , the device turns off internal MOSFET to protect itself. The device exits thermal shutdown after junction temperature cools down below $T_{SD}-T_{HYS}$. And then the device full works after a soft start period.

5.5 SS function

To avoid high inrush current, YHM2029 integrated soft-start function. When EN status changes from logic 0 to logic 1 or from thermal shutdown mode, YHM2029 will regulate output current for about 1ms and then enter full function status.

5.6 Output discharge

YHM2029 has output discharge function. The V_{OUT} connects to GND with 150ohm resistor when EN=0 or thermal shutdown mode for 2ms and then disconnects this resistor.

YHM2029

400mA Ultra-Low Noise/High PSRR LDO

6 Package Dimensions

WLCSP-4

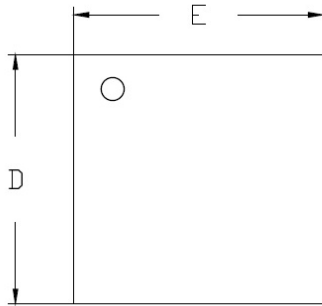

TOP VIEW
(MARK SIDE)

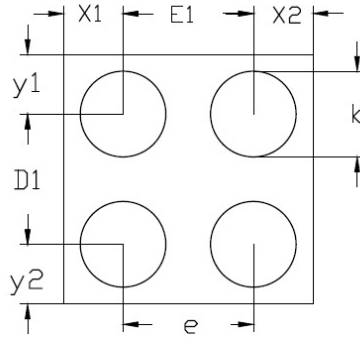

BOTTOM VIEW
(BALL SIDE)

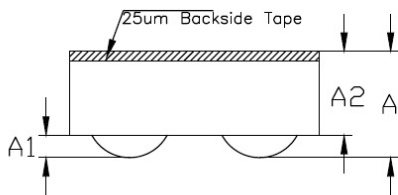

SIDE VIEW

NOTES:
ALL WAFER ORIENTATION NOTCH DOWN

COMMON DIMENSIONS
(UNITS OF MEASURE=MILLIMETER)

SYMBOL	MIN	NOM	MAX
A	0.240	0.285	0.330
A1	0.040	0.060	0.080
A2	0.200	0.225	0.250
D	0.650	0.670	0.690
D1	0.350BSC		
E	0.650	0.670	0.690
E1	0.350BSC		
b	0.180	0.200	0.220
e	0.350 BSC		
x1	0.160 REF		
x2	0.160 REF		
y1	0.160 REF		
y2	0.160 REF		

YHMICROS

YHM2029

400mA Ultra-Low Noise/High PSRR LDO

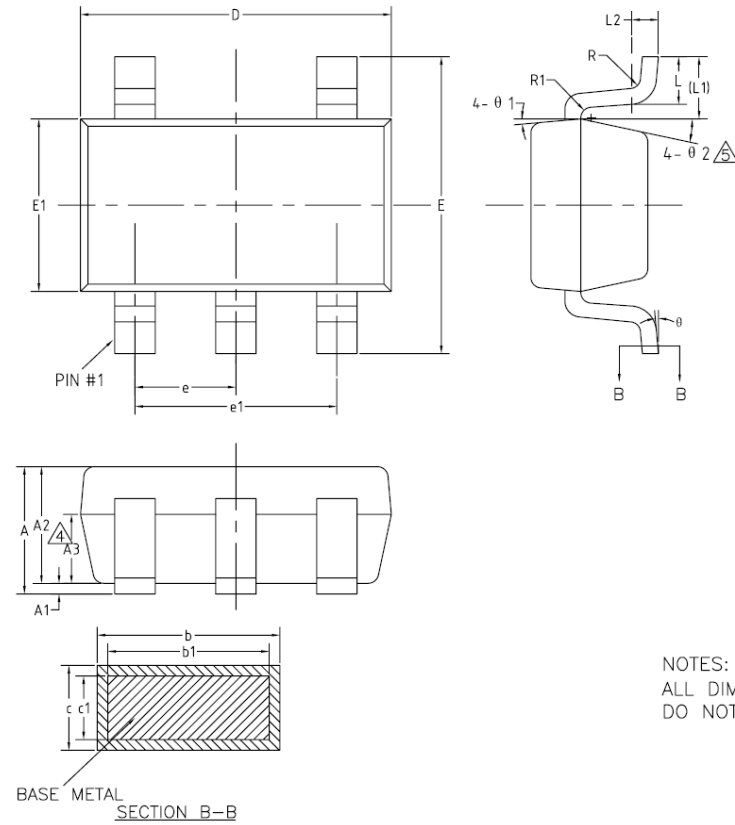
SOT23-5

 COMMON DIMENSIONS
 (UNITS OF MEASURE=MILLIMETER)

SYMBOL	MIN	NOM	MAX
A	—	—	1.25
A1	0	—	0.15
A2	1.00	1.10	1.20
A3	0.60	0.65	0.70
b	0.36	—	0.50
b1	0.36	0.38	0.45
c	0.14	—	0.20
c1	0.14	0.15	0.16
D	2.826	2.926	3.026
E	2.60	2.80	3.00
E1	1.526	1.626	1.726
e	0.90	0.95	1.00
e1	1.80	1.90	2.00
L	0.35	0.45	0.60
L1	0.59REF		
L2	0.25BSC		
R	0.10	—	—
R1	0.10	—	0.25
θ	0°	—	8°
θ 1	3°	5°	7°
θ 2	6°	—	14°

NOTES:

ALL DIMENSIONS REFER TO JEDEC STANDARD MO-178 AA
 DO NOT INCLUDE MOLD FLASH OR PROTRUSIONS.

YHMICROS

YHM2029

400mA Ultra-Low Noise/High PSRR LDO

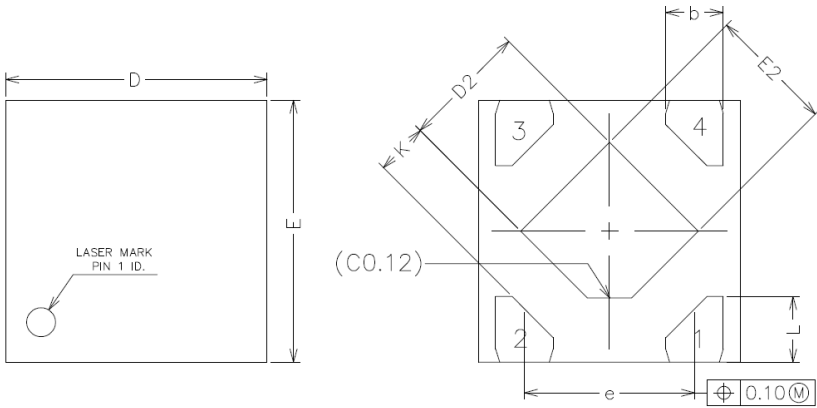
DFN-4

 COMMON DIMENSIONS
 (UNITS OF MEASURE=MILLIMETER)

SYMBOL	MIN	NOM	MAX
A	0.34	0.37	0.40
A1	0.00	0.02	0.05
A3	0.10REF		
b	0.17	0.22	0.27
D	0.95	1.00	1.05
E	0.95	1.00	1.05
D2	0.43	0.48	0.53
E2	0.43	0.48	0.53
L	0.20	0.25	0.30
e	0.60	0.65	0.70
K	0.15	-	-

TOP VIEW

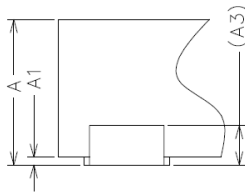
BOTTOM VIEW



DETAIL A

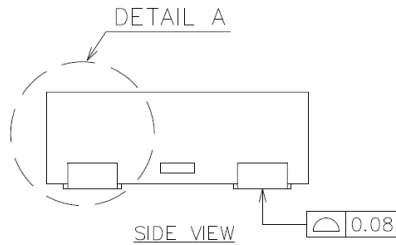

SIDE VIEW

 NOTES:
 ALL DIMENSIONS DO NOT INCLUDE MOLD FLASH OR PROTRUSION.

7 Ordering Information

Part Number	Package	Output Voltage (V)	Top Mark (Note 1)	MOQ
YHM2029W4T09	4 WLCSP	0.9	xx	5000
YHM2029W4T12	4 WLCSP	1.2	xx	5000
YHM2029W4T15	4 WLCSP	1.5	xx	5000
YHM2029W4T18	4 WLCSP	1.8	xx	5000
YHM2029W4T20	4 WLCSP	2.0	xx	5000
YHM2029W4T22	4 WLCSP	2.2	xx	5000
YHM2029W4T25	4 WLCSP	2.5	xx	5000
YHM2029W4T27	4 WLCSP	2.7	xx	5000
YHM2029W4T28	4 WLCSP	2.8	xx	5000
YHM2029W4T285	4 WLCSP	2.85	xx	5000
YHM2029W4T30	4 WLCSP	3	xx	5000
YHM2029W4T31	4 WLCSP	3.1	xx	5000
YHM2029W4T32	4 WLCSP	3.2	xx	5000
YHM2029W4T33	4 WLCSP	3.3	xx	5000
YHM2029W4T35	4 WLCSP	3.5	xx	5000
YHM2029W4T45	4 WLCSP	4.5	xx	5000
YHM2029S5T09	5 SOT23	0.9	2029x	3000
YHM2029S5T12	5 SOT23	1.2	2029x	3000
YHM2029S5T15	5 SOT23	1.5	2029x	3000
YHM2029S5T18	5 SOT23	1.8	2029x	3000
YHM2029S5T20	5 SOT23	2.0	2029x	3000
YHM2029S5T22	5 SOT23	2.2	2029x	3000
YHM2029S5T25	5 SOT23	2.5	2029x	3000
YHM2029S5T27	5 SOT23	2.7	2029x	3000
YHM2029S5T28	5 SOT23	2.8	2029x	3000
YHM2029S5T285	5 SOT23	2.85	2029x	3000
YHM2029S5T30	5 SOT23	3	2029x	3000
YHM2029S5T31	5 SOT23	3.1	2029x	3000
YHM2029S5T32	5 SOT23	3.2	2029x	3000
YHM2029S5T33	5 SOT23	3.3	2029x	3000
YHM2029S5T35	5 SOT23	3.5	2029x	3000
YHM2029S5T45	5 SOT23	4.5	2029x	3000
YHM2029D4T09	4 DFN	0.9	xx	3000
YHM2029D4T12	4 DFN	1.2	xx	3000
YHM2029D4T15	4 DFN	1.5	xx	3000
YHM2029D4T18	4 DFN	1.8	xx	3000
YHM2029D4T20	4 DFN	2.0	xx	3000
YHM2029D4T22	4 DFN	2.2	xx	3000
YHM2029D4T25	4 DFN	2.5	xx	3000

YHM2029

400mA Ultra-Low Noise/High PSRR LDO



Preliminary V3.0

Part Number	Package	Output Voltage (V)	Top Mark (Note 1)	MOQ
YHM2029D4T27	4 DFN	2.7	xx	3000
YHM2029D4T28	4 DFN	2.8	xx	3000
YHM2029D4T285	4 DFN	2.85	xx	3000
YHM2029D4T30	4 DFN	3	xx	3000
YHM2029D4T31	4 DFN	3.1	xx	3000
YHM2029D4T32	4 DFN	3.2	xx	3000
YHM2029D4T33	4 DFN	3.3	xx	3000
YHM2029D4T35	4 DFN	3.5	xx	3000
YHM2029D4T45	4 DFN	4.5	xx	3000

T = Tape and reel.

Note: xx or x is tracking numbers for internal usage.

8 Datasheet Change History

Rev	Date	Changes
1.0	May/2023	Initial Version
2.0	July/2023	1. Change VIN range to 1.7~5.5V 2. Change UVLO threshold to 1.5V.
3.0	Oct/2023	1. Add 1.6V VIN note 2. Add DFN package and order information.

YHMICROS CONFIDENTIAL